

PUIaudio

Data Sheet ABLF2036B-LW100

Features

- Lead Free Piezoelectric Bender

Specifications

Parameters	Values	Units
Resonant Frequency	3,600 ± 500	Hz
Resonant Impedance (Max)	500	Ohms
Max Input Voltage	30	Vp-p
Capacitance (@ 120 Hz)	25,000 ± 30%	pF
Plate Material	Brass	-
Lead Wire Material	UL1571 AWG28	-
Storage Temperature	-20 ~ +70	°C
Operating Temperature	-20 ~ +60	°C
Environmental Compliances	RoHS/REACH	

Dimensions

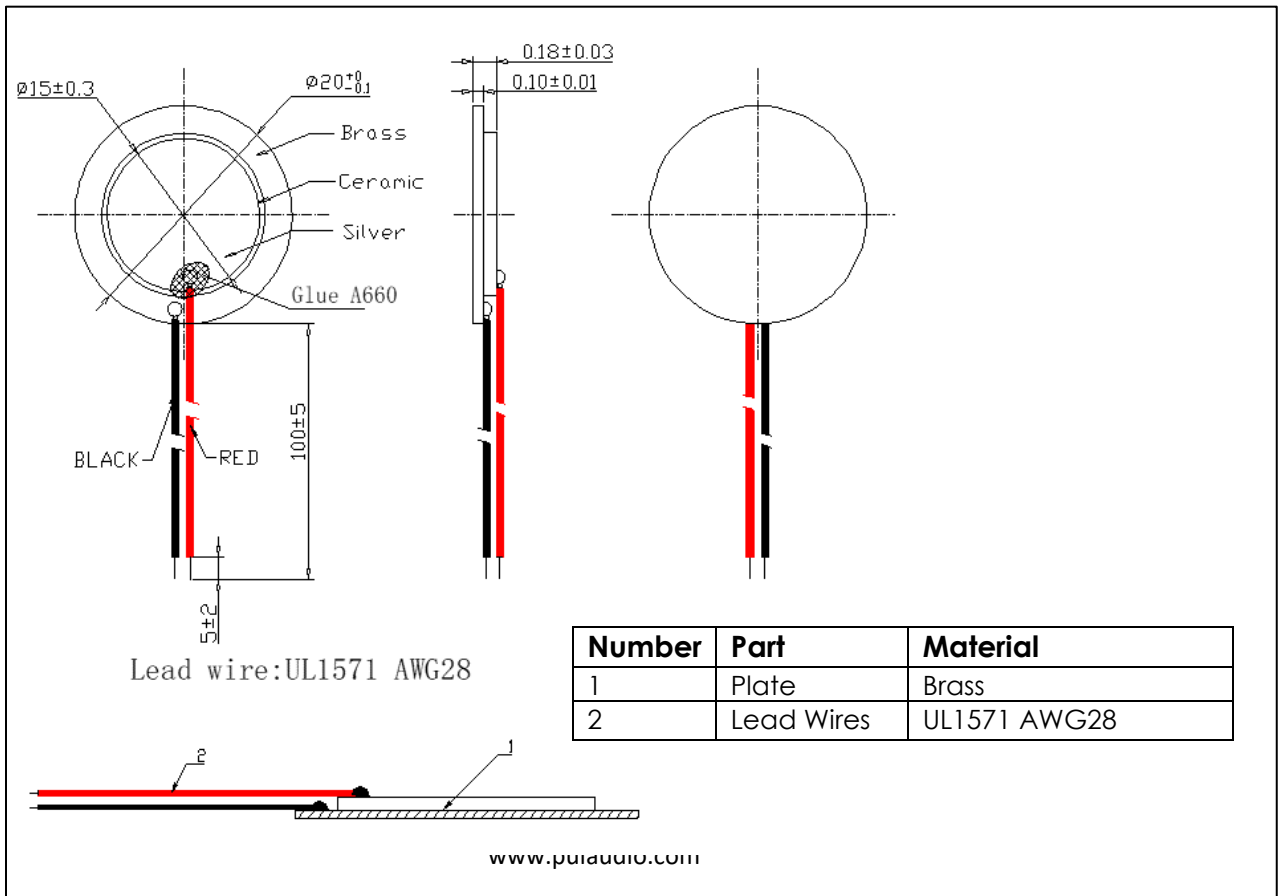

Packaging

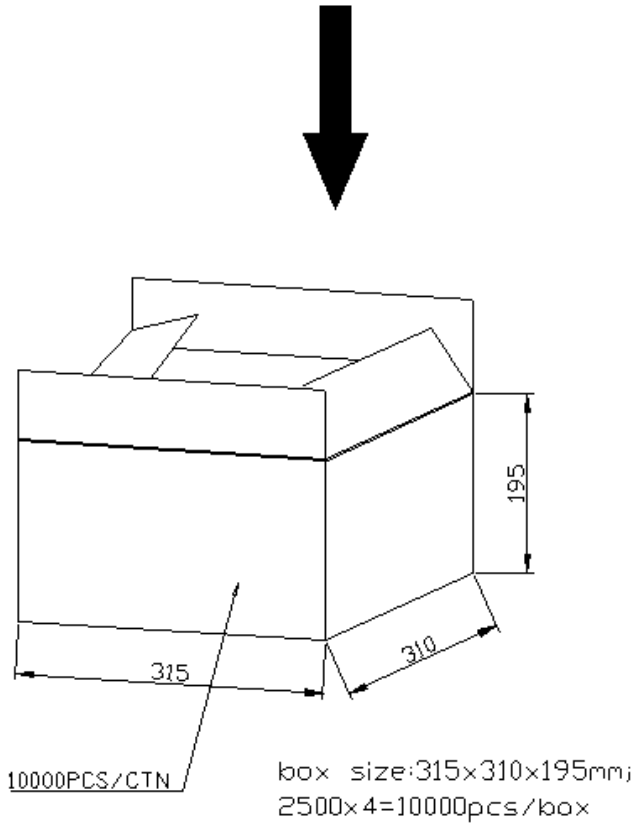
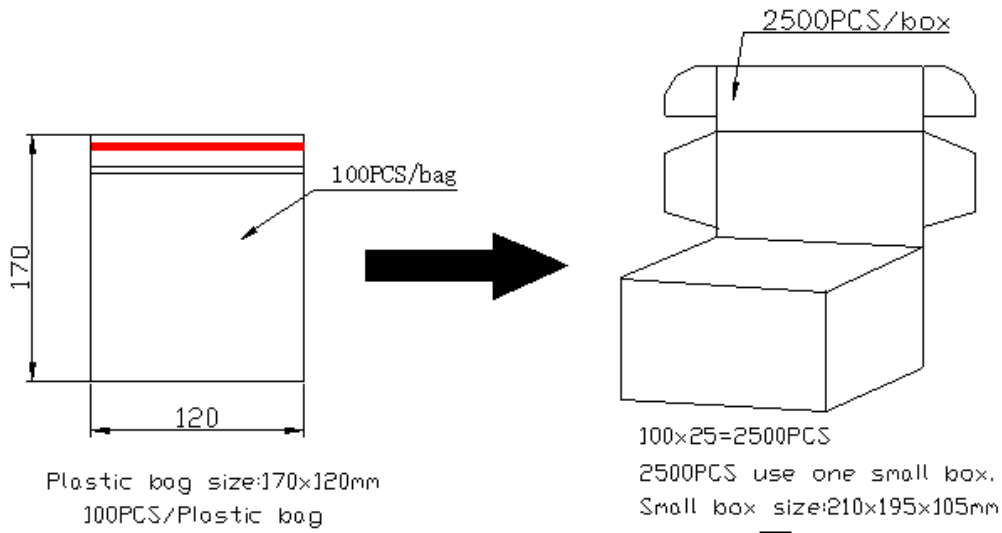

Packaging	QTY
Bag	100 pcs
Box	2,500 pcs
Carton	10,000 pcs

Specifications Revisions

Revision	Description	Date
A	RELEASED FROM ENGINEERING	7/14/2023

Note:

- 1. Unless otherwise specified:
 - A. All dimensions are in millimeters.
 - B. Default tolerances are $\pm 0.5\text{mm}$ and angles are $\pm 3^\circ$.
- 2. Specifications subject to change or withdrawal without notice.